

# IRON

---

FRENCH RETURN ROD



---

# CROWN

T 601.924.0669  
TF 866.922.7056 F 601.460.4736  
CROWNROD.COM

# RETURN

FRENCH RETURNS PROJECTIONS ARE MEASURED FROM THE WALL TO THE CENTER OF THE ROD.  
 ROD WIDTH IS MEASURED FROM THE OUTSIDE OF EACH RETURN.

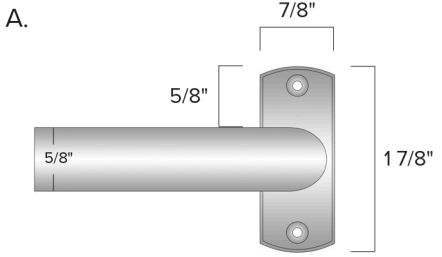

48" SPAN BETWEEN BRACKETS  
 STANDARD RETURN - 2 1/2"  
 MINIMUM RETURN - 2"

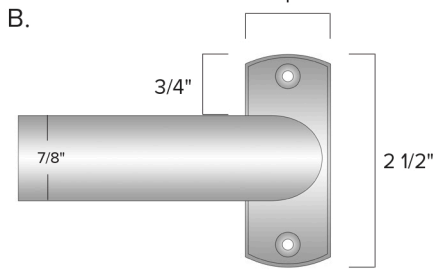

72" SPAN BETWEEN BRACKETS  
 STANDARD RETURN - 3 1/2"  
 MINIMUM RETURN - 2 3/4"

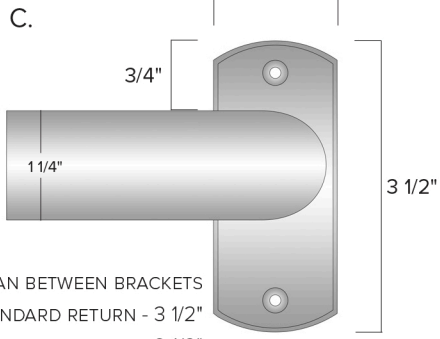

96" SPAN BETWEEN BRACKETS  
 STANDARD RETURN - 3 1/2"  
 MINIMUM RETURN - 3 1/2"

# RING

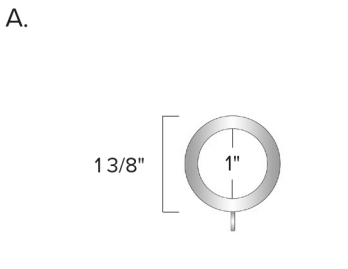

RING DEDUCTION 1 3/16"

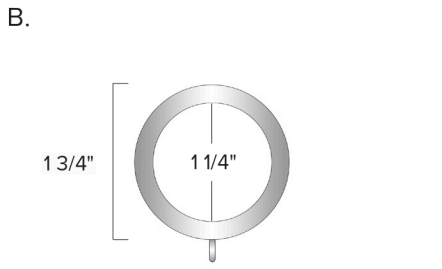

RING DEDUCTION 1 1/2"

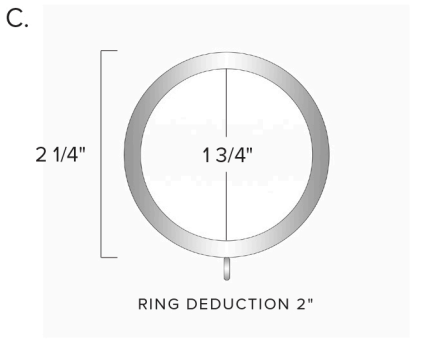

RING DEDUCTION 2"

# BRACKET

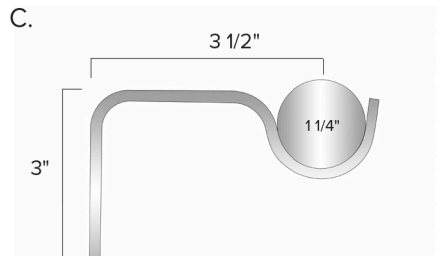
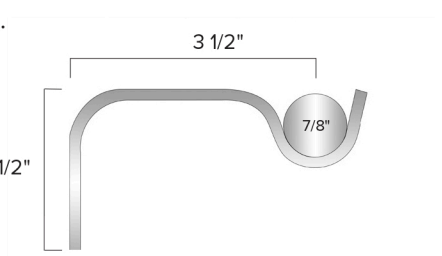
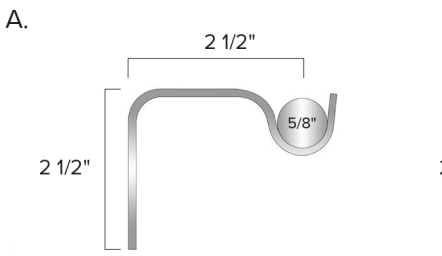

# IRON

## FRENCH RETURN ROD

### RETURN

- A. 5FR
- B. 7FR
- C. 1FR

### RING

- A. 5R
- B. 7R
- C. 1R

### BRACKET

- A. 5B2.5
- B. 7B3.5
- C. 1B3.5

### FINISHES

SHOWN IN VINTAGE GOLD - ALSO AVAILABLE IN CLASSIC, MATTE, AND ARTISAN FINISHES

BRACKETS, RETURNS, AND RINGS ARE SHOWN IN STANDARD PROJECTIONS AND SIZES -- CUSTOM PROJECTIONS ARE AVAILABLE

# CROWN

T 601.924.0669  
 TF 866.922.7056 F 601.460.4736  
 CROWNROD.COM